

## APIJUNEDA CATALOG OF BEEKEEPING CLAMPS

AJ IS A COMPLETE  
SOLUTION FOR  
ALL BEEKEEPERS  
WORK



**Model V**



**Model NV**



**Model Multi**

**IMAGE 1**

### INDEX

#### INTRODUCTION

<u>CLAMP MULTI</u>	<u>p. 1</u>
<u>OPCIONES</u>	<u>p.2</u>
<u>CLAMP NV</u>	<u>p. 3</u>
<u>CLAMP V</u>	<u>p. 4</u>
<u>CLAMPS ON ORDER</u>	<u>p. 5</u>

# CLAMPS MODEL MULTI



[inches] mm      **Weight: 20 kg /44 Lb**      **Capacity: 200 kg / 441 Lb**

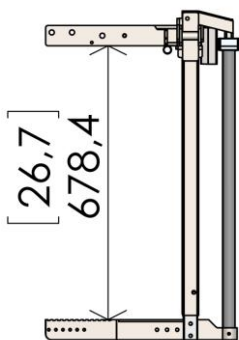

DIMENSION CLOSED  
FOR (49,9) In 1267 Open

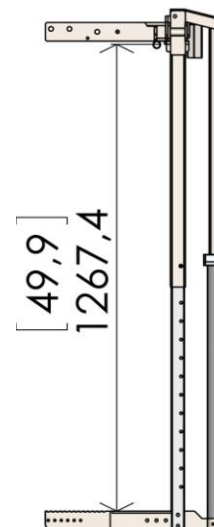

(63,05) In 1600 mm ON REQUEST

## DESCRIPTION:

- ✓ MULTI clamps have been designed to perform all weight management tasks in the apiary.
- ✓ Its vertical arms provide comfort and ergonomics.
- ✓ MULTI clamps are adjustable in height and width to adapt to all hives on the market.
- ✓ **Multi clamps are delivered as seen in the image above, optional accessories are explained in this document and must be selected in the order form.**
- ✓ From the clamp bars, in all their height you have the control of the most important functions. Up fast, Down fast, Up slow, Down slow, Brake, Unbrake, and Level.
- ✓ *We have given the maximum possible height for his load capacity. But we know that there are customers who prefer it with less height, but retaining the model's properties. For this reason it is possible to reduce its height easily just by cutting the vertical arms.*

(indicate on the order form if you want that we make this reduction)

## USES:

On pallet

Flat Hives

Column Stand. Arms  
In (49,9) 1267 mm

Column B-L Arms  
In (63,05) 1600 mm

Harvest Supers

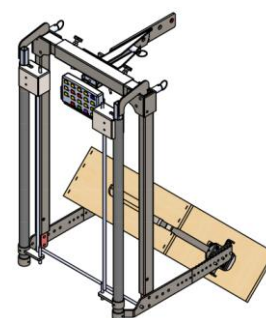
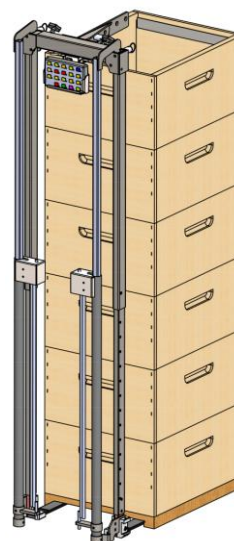
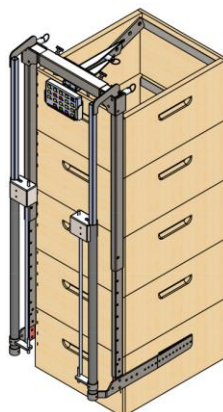
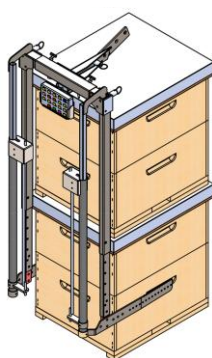
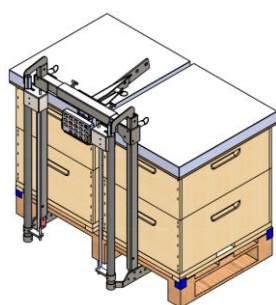

- Fixed right arm at 90°.
- Left arm oscillating, can be limited.
- Adjustable vertical and horizontal distance.

## DETAILS:

- 5 main functions in the tactile rods.
- Security press.
- Oscillation of the press are lockable.



## WITH STANDARD FORKS :

With the arms delivered as standard, the clamps can be configured with the options as shown in the images.

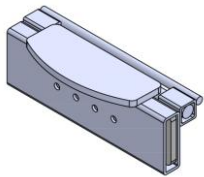
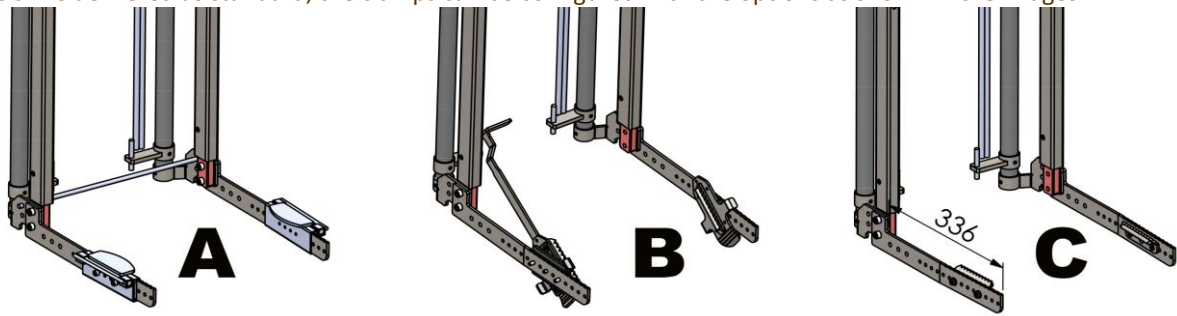

**A) FLAT SYSTEM:** To lift hives, supers or supers pile. The arms work at a fixed distance, the plates are raised alone when touching the rise and position themselves to coincide with the hollow of the hands. **VALID: Multi**



**C) GR SYSTEM:** They can be installed directly on the arms or in the PÍVOT system. To lift hives, supers or supers pile. The left arm must be unlocked to work like a clamp. The round piece allows the assembly to slide until it finds the hole, then the serrated piece makes a firm grip. **VALID: Multi, NV, V.**

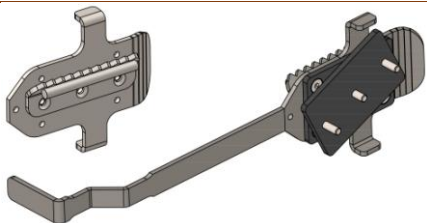

### B) PÍVOT SYSTEM:

It allows to pivot the supers in two directions to blow the bees. It requires that the left arm is free for the GR parts can enter on the hands hole, the elastic with hook delivered, maintains tension between the arms so that the super can turn safely. **VALID: Multi, NV, V.**

## WITH B-L FORKS:

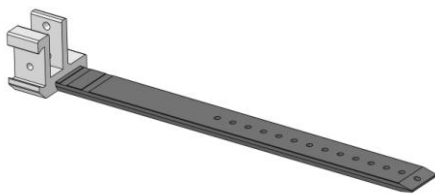
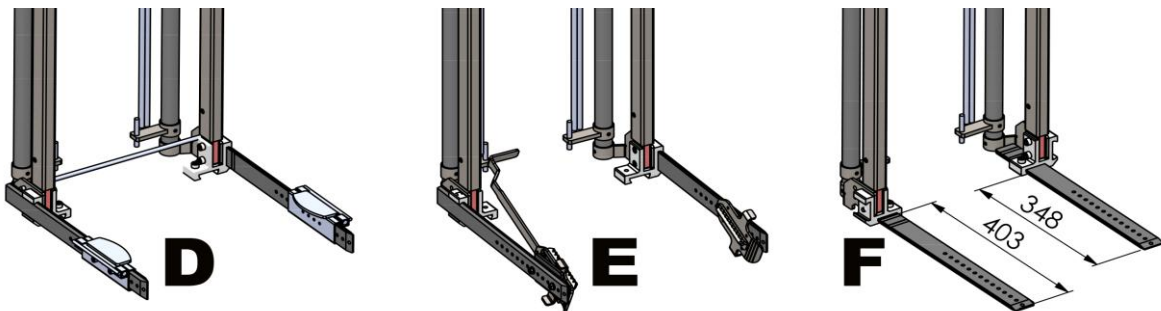

**B-L SYSTEM:** IF YOU SELECT THIS SYSTEM, THE STANDART ARMS WILL NOT BE INCLUDED, IF YOU WANT THE TWO TYPES INDICATE IT IN THE ORDER SHEET.

This system allows to mount horizontal arms to catch bodies from the bottom or vertical to catch bodies through the hands holes, with the PÍVOT or FLAT system. A set screw presses each arm to prevent movement and also allows you to choose the desired arm length. In a horizontal position between 403 and 348 mm (F), In vertical position it can be reduced at will.

**VALID: Multi**

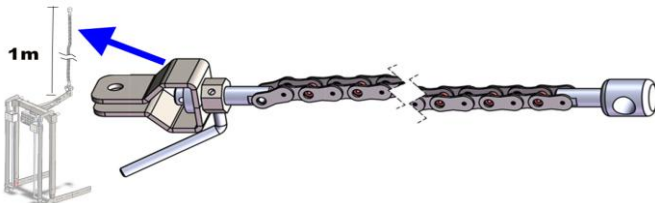

### BLOCKING CHAIN ASSEMBLY:

**Length 1 m / 39,37 in.**

It allows to block the rotation that the clamp makes when it is not held by the operator, in this way when we take it again, it will be in the same position that we left it.

**VALID: Multi, NV, V.**

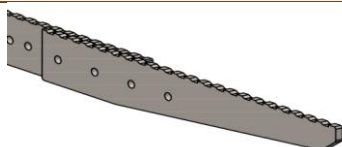

### EXTENSION OF THE STANDARD ARMS:

Select these parts if you use iron pallets and the Standart arms do not reach the pallet rails. The wooden pallets have boards in the middle that are sufficient to support and balance the load without the need extension, in addition to the clamp press, arms as long as the hive are not necessary.

**VALID: Multi, NV, V.**

# CLAMP MODEL NV



[inches] mm      weight: 17 KG/ 37,5 Lb      Capacity: 200 Kg / 441 Lb

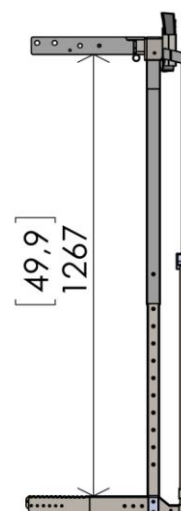
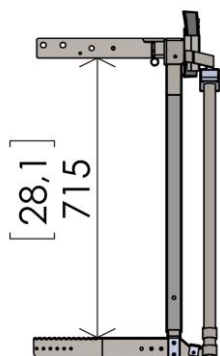

## DESCRIPTION:

- ✓ NV clamps have been designed to perform all weight management tasks in the apiary.
- ✓ **NV clamps are delivered as seen in the image 1, optional accessories are explained in this document and must be selected in the order form.**
- ✓ From the clamp bars, in all their height you have the control of the most important functions. Up fast, Down fast, Up slow, Gown slow, Brake, Unbrake, and Level.
- ✓ We have given the maximum possible height for his load capacity. But we know that there are customers who prefer it with less height, but retaining the model's properties. For this reason it is possible to reduce its height easily just by cutting the vertical arms.
- ✓ (indicate on the order form if you want that we make this reduction)

## USES:

Beehives on pallet

Flat hives without pallets

Supers pile

Harvest of supers

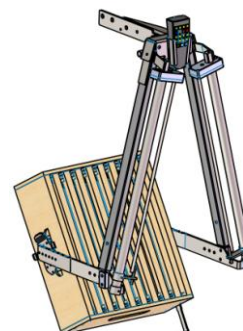
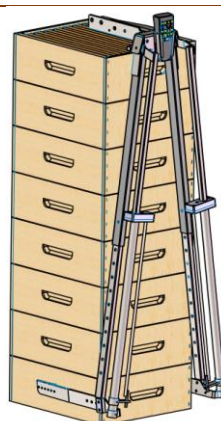
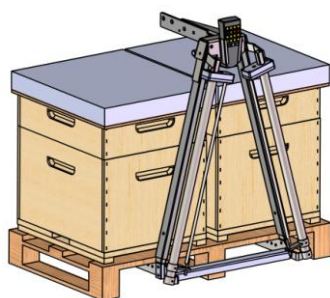

- Arms with limitable and lockable oscillation
- Adjustable vertical distance.
- 5 main functions in the tactile rods.

## DETAILS:

- Security press.
- Oscillation of the press are lockable.





(inches) mm

Weight: 9 KG / 18,8 Lb

Capacity: 150 Kg / 330 Lb



## DESCRIPTION:

- ✓ The V clamps were designed to perform all tasks in beekeeping work.
- ✓ **V clamps are delivered as seen in the image 1, optional accessories are explained in this document and must be selected in the order form.**
- ✓ From the buttons, without leaving the hands of the supports has the following functions:  
Up fast, Down fast, Up slow, Down slow, Brake, Unbrake, and Level.

## SOME USES:

Beehives on pallet

Flat hives without pallets

Supers pile

Harvest of supers

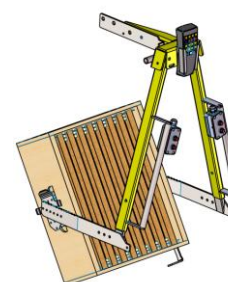
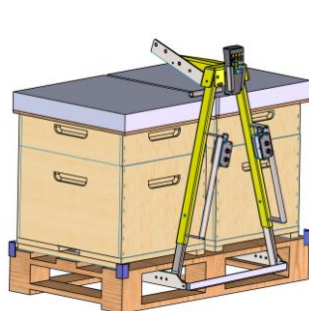

## DETAILS:

- Arms with limitable and lockable oscillation
- Adjustable vertical distance.
- 5 main functions in the buttons
- Security press.
- Oscillation of the press are lockable.



## SPECIAL MODELS

### DESCRIPTION:

Some customers want particular clamps for different reasons.

We are open to any proposal and we adapt the functions of the crane to its clamp model.

Up fast, Down fast, Up slow, Down slow, Brake, Unbrake, and Level.



## SOME USES:

Beehives on pallet

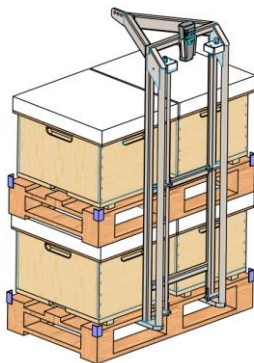

Flat hives without pallets



Supers pile



## DETAILS:

- 5 main functions in the tactile rods
- Fixed height
- Functions available throughout the height of the clamp.
- Fixed width

## PALLET OPTIONS:

